

I.Dekk®

By DuxxBak Composite Decking
A Division of Green Bay Decking, LLC

DECKING INSTALLATION INSTRUCTIONS



PLEASE READ AND FOLLOW THESE INSTALLATION INSTRUCTIONS FOR A SUCCESSFUL I.DEKK PROJECT

Select the best board profile for your deck. I.Dekk is offered in a Traditional S4S deck board, which is a rectangular profile and is gapped between boards, as well as in a Tongue & Groove deck board that allows for a continuous deck surface.



Traditional S4S boards are your best choice if debris from trees or other sources is a consideration. S4S boards are also the best option if air circulation under the deck will be limited, as most structural materials require air circulation to avoid degradation resulting from moisture build-up. The gap between boards aids in air circulation.



Tongue & Groove boards can be used when sufficient air circulation can be provided to the deck substructure. While I.Dekk boards don't require any ventilation, most structural materials require it.

Tongue and Groove boards should always be gapped 1/32" to 1/16" to allow for expansion and contraction related to variations in temperature. Using a Green Bay Decking gapping tool can simplify the gapping process and deliver premium results.

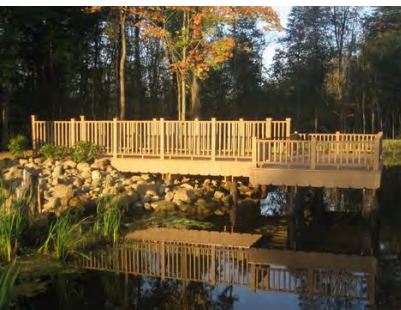

Careful installation protects your deck.



Important Installation Tips

Please read and follow these installation tips for a successful I.Dekk installation

All composite decking will expand and contract as temperatures change. To minimize adverse effects resulting from such changes, it is best to install deck boards during moderate temperatures. Avoid installation during temperature extremes.

Proper gapping should be provided throughout the deck installation. A minimum gap of 1/8" should be provided where the deck meets a wall and a 3/16" gap should be provided where the deck meets a post or other object. Tongue and groove boards should be gapped at a minimum of 1/32" between boards. (Use of the DuxxBak Composite Decking gapping tool is recommended). Traditional, rectangular S4S boards should be installed with a minimum 3/16" gap.

Be sure to use the recommended fastener for your application. Genuine DuxxBak Composite Decking fasteners will deliver optimum results.

All face fasteners should be located at least 3/4" from the ends and edges of the deck boards. Fasteners should be placed near the deck board structural septa.

Quality framing materials and proper building techniques will help assure a successful project. A slight deck slope of 1/16" per foot away from the house is recommended. Always use a chalk line to establish a straight line, and check level and plane as construction proceeds. Always calculate deck width to avoid having to rip a deck board or to have an adequately sized board if a board must be ripped.

Deck boards should be laid out prior to installation to achieve the most pleasing pattern and brush tone visual effect.

Complete installation and care instructions can be found on our website at www.duxxbakdecking.com.

Please call DuxxBak Composite Decking at 877-804-0137 for additional information.

Thank you for selecting.



I.Dekk®

Deck Components and Specifications



TRADITIONAL S4S
 Description: 5/4" x 6" S4S
 Height: 1 1/4"
 Width: 5 1/2"
 Lengths: 12', 16', 20'
 Weight: 1.4 lbs./ft.



PERIMETER STRIP
 Description: 6/4" x 6"
 Height: 1 1/2"
 Width: 5 1/2"
 Length: 12'
 Weight: 1.6 lbs./ft.



TONGUE & GROOVE
 Description: 5/4" x 6"
 Height: 1 1/4"
 Width: 5 3/4"
 Lengths: 12', 16', 20'
 Weight: 1.37 lbs./ft.



FEATURE STRIP
 Description: 6/4" x 6"
 Height: 1 1/2"
 Width: 5 1/2"
 Length: 12'
 Weight: 1.4 lbs./ft.



BALUSTERS
 Description: 2" x 2"
 Height: 1 3/4"
 Width: 1 3/4"
 Lengths: 32", 38"
 Weights: 32" 2.3 lbs., 38" 2.6 lb

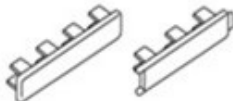

*End Caps available for all profiles

END CAP*
 Height: 1 1/4"
 Width: 5 1/2"
 Length: 1"
 Weight: .2



4" X 4" POST SLEEVE
 Height: 4.315"
 Width: 4.315"
 Length: 8"
 Weight: 17.6 lbs.



FASCIA BOARD
 Height: 7/16"
 Width: 12"
 Length: 12'
 Weight: 2.5 lbs



6" X 6" POST SLEEVE
 Height: 6.410"
 Width: 6.410"
 Length: 12'
 Weight: 39.5 lbs.



POST CAP
 Height: 4"
 Width: 4"
 Weight: .22 lbs.
 Notes: Standard Post Cap
 also available in 6" x 6"



POST BASE TRIM
 Height: 4"
 Width: 4"
 Weight: .20 lbs.
 Notes: Standard Post Base Trim
 also available in 6" x 6"

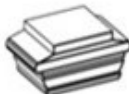

DECORATIVE POST CAP
 Height: 4"
 Width: 4"
 Weight: .22 lbs.

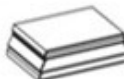

DECORATIVE POST BASE TRIM
 Height: 4"
 Width: 4"
 Weight: .20 lbs.

TABLE OF CONTENTS

General Introduction	5
Local Building Codes	5
Installation Tools	5
Scheduling Your Project	6
Unloading, Storage, and Handling	6
Cautions	6
Expansion and Contraction	6
Sub-Structure Framing	6
Installing Feature & Perimeter Strips	6
Blocking	7
Joist Spacing	7
Stair Tread.....	7
Under Deck Air Circulation.....	8
Deck Drainage	8
Water Drainage Systems	8
General Guidelines	9
Board Layout	9
Perimeter & Feature Strip Installation.....	9
Board Spacing	9
Board Gapping	9
Fasteners	10
Installation	12
Parallel or Perpendicular Decking	12
Diagonal Decking	13
Feature and Perimeter Strips	14
Fascia Boards	14
Warranty Registration Information	15

CLEANING YOUR I.DEKK

Occasional light cleaning will keep your deck looking fresh. Additionally, regular cleaning may help Tongue & Groove boards to drain properly. A pressure washer may be used with a fan-tip that is guided to move in the direction of the deck grain. Be careful not to damage the boards and follow proper safety precautions.

Scratches

Although **I.Dekk** is durable, care should be taken to avoid scratching. If scratches do appear, it may be possible to carefully draw a stainless brush across the scratches in the direction of the grain to remove or reduce the scratches. Always test a small area to make sure the surface texture is not damaged.

Removing Stains

Most stains can be removed with a general-purpose household cleaner, concentrated dish soap, laundry detergent, degreaser or composite deck cleaner. A plastic bristle brush will make the task easier. Remember that it is usually easier to remove fresh stains.

Removing Microbial Stains

Microbial stains, such as algae and black mold, will not damage your **I.Dekk**. Algae and black mold can generally be removed with a pressure washer and plastic bristle scrub brush, and cleaners designed to remove mold and mildew. Always test a small area before proceeding.

Please go to www.duxxbakdecking.com for additional tips.

GENERAL INTRODUCTION

I.Dekk is available in:

- **S4S Profile:** 5/4" Traditional (S4S)
 - Available in 12', 16' and 20' lengths
- **Tongue & Groove Profile:** 5/4" T&G
 - Available in 12', 16' and 20' lengths

I.Dekk trim boards are available in two profiles:

- **Feature Strips:** Provides an attractive divider strip on the main deck.
 - Available in 12' lengths
- **Perimeter Strip:** Provides an attractive alternative picture frame of the main deck.
 - Available in 12' and 20' lengths

I.Dekk comes in a variety of colors. See the Color Selector at www.duxxbakdecking.com for more details.

The complete **I.Dekk** system includes boards, post sleeves, railings, balusters, end caps, post caps, post base trim, and handrail collars — everything needed to create a great-looking deck.

All **I.Dekk** boards manufactured by DuxxBak Composite Decking are identified with laser engraved identification data, which can be found at 4 foot intervals on the edge of each board. This identification includes the manufacturer's name, the date the product was manufactured, and the ICC report number - ESR 1369. This information is helpful to local building code administrators.

Since **I.Dekk** is made from a formulation of reclaimed paper by-product, rice hulls (a rapidly renewable resource), and other high-quality materials, its properties differ from those of wood products. Therefore, **I.Dekk** has different handling and installation requirements that should be taken into consideration during the planning of your deck installation.

The following illustrated instructions have been provided to help you understand and take advantage of these differences with appropriate installation techniques. Following these instructions, along with good building practices, will deliver the highest quality installation, and will assure many years of outdoor living enjoyment.

Local Building Codes

You will want to follow all local building codes and good construction practices as you design and build your deck. Most municipal building codes have specific deck construction requirements. Failure to follow local building codes, including filing plans and scheduling inspections with the municipal building inspector, may result in costly post-construction modifications. In addition to local codes, be sure to follow the instructions in this manual that specifically pertain to **I.Dekk** products. Failure to do so may affect your DuxxBak Composite Decking warranty. Feel free to contact us toll free if you have questions on any of our products, or to assist in locating a quality decking professional.

Installation Tools

Typical woodworking tools can be used. No pre-drilling or special drill bits required. Your deck can be installed using the fasteners shown on page 9.

SCHEDULING YOUR PROJECT

Unloading, Storage, and Handling I.Dekk

I.Dekk boards should be stored on a dry, flat surface with support every 48 inches. Do not stack I.Dekk more than four skids high. Cutting and drilling of I.Dekk does not produce respirable dust. However, it is good practice to always wear protective equipment such as safety glasses and hearing protection when operating power equipment.

Cautions



Expansion and Contraction

Every material expands and contracts as temperatures change, and composite decking is no exception. Avoid potential problems by allowing time for proper acclimation of I.Dekk to local temperatures.

It is best to mark, cut, and install boards when they are all at roughly the same temperature.

It is recommended that all boards be kept at similar temperatures. **Boards that have been in the sun for several hours will have expanded more than those kept in the shade, and consequently will contract more when they cool.**

If possible, install I.Dekk during the coolest part of the day. Although the ideal temperature for installation is 60 degrees Fahrenheit, this is not always possible. Thus, these steps help reduce the effects of expansion and contraction: storing boards in the shade; making final cuts after boards have cooled.

SUB-STRUCTURE FRAMING

Installing Feature & Perimeter Strips

Layout your deck using current framing techniques outlined in the International Residential Code (IRC), as well as local code requirements.

In addition to standard framing practices, additional blocking is required as outlined in this section. The cutaway detail graphic shows the joist, 2x4 spacer, and blocking border. This framing system provides a solid support for your deck, perimeter strip and feature strip.

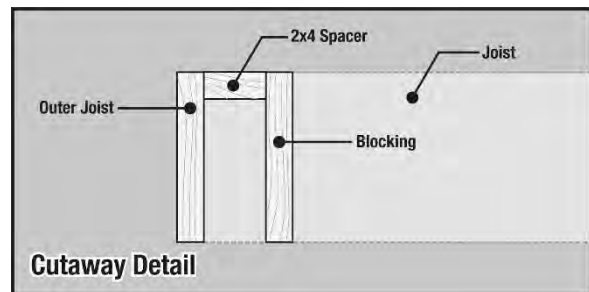

The following two illustrations show how to complete a corner with and without a post using the same framing techniques.

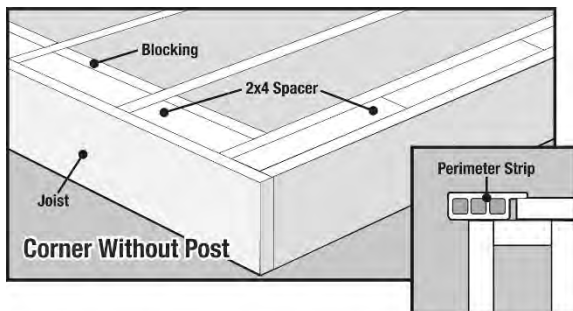
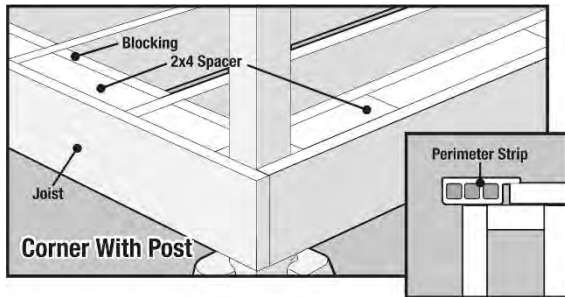

The intermediate joist is the framing necessary for Feature Strips.

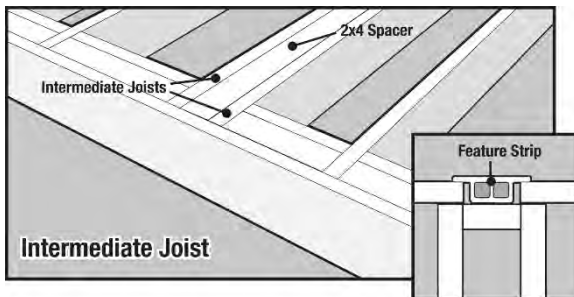

Blocking

Center blocking ties the joist together to complete the framing. It will keep joists from twisting and bowing and keep the deck square. Blocking should be installed every 6' along joist, or if less than 12', mid-span.

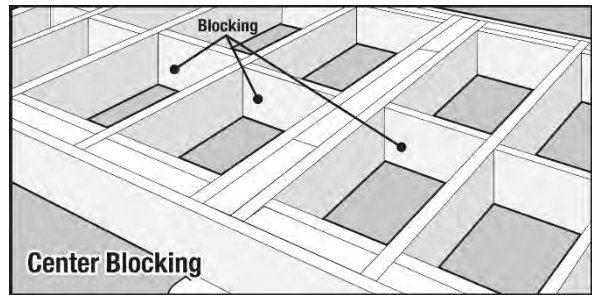

Joist Spacing

I.Dekk decking should be installed on joists spaced no more than 16" on center for perpendicular or diagonal installations.

Be certain that the joist system is properly squared and secured with center blocking.

Stair Tread

I.Dekk deck boards being used as stair treads should be installed on joists spaced no more than 12" on center.

Under Deck Air Circulation

Traditional S4S deck board should be selected if under deck air circulation will be limited as the deck substructure does require sufficient air circulation to remain stable. The minimum 3/16" spacing between boards aides in air circulation.

Tongue and Groove deck boards may be selected when sufficient air circulation can be provided to the deck substructure by allowing air to enter on at least two sides of the deck. The amount of open space may be based on soil and moisture conditions. As a general rule at least 12" of unimpeded space should be available. Lattice may be an acceptable substructure cover. Tongue and Groove boards should always be gapped 1/32" to 1/16" to allow for expansion and contraction.

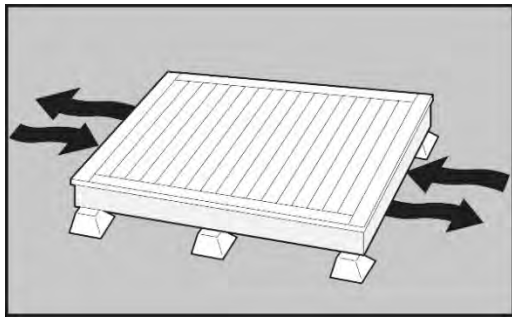

Deck Drainage

Slope the deck slightly (1/16" per foot) away from the house for water run-off, particularly for Tongue & Groove boards. Proper flashing of the ledger board is essential. Proper slope will help assure that will properly drain from the deck.

Water Drainage Systems

Water drainage systems such as an EPDM type membrane or a commercially available under deck drainage system, may be used with Traditional S4S deck boards assuming that the boards are spaced at 3/16" or more. This spacing will assure adequate water drainage and will also allow for air circulation.

Tongue and Groove deck boards should generally not be used with an underdeck drainage system as sufficient air circulation may not be available for proper air circulation.

GENERAL GUIDELINES

Board Layout

Avoid installing deck boards end to end.

An **I.Dekk Feature Strip** provides an ideal way to avoid butt joints as space can be provided for normal expansion and contraction under the wings of the Feature Strip. Avoid placing fasteners through the wings of the Feature Strip.

Do Not

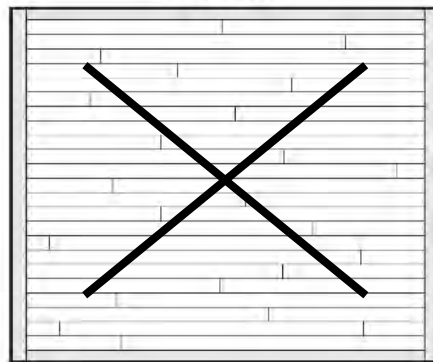

Perimeter or Feature Strip Installation:

I.Dekk Perimeter Strips may have to be butted together if the outer edge of the deck is being “picture framed”. If the deck has a rail system, it is recommended you butt the Perimeter Strips at the post.

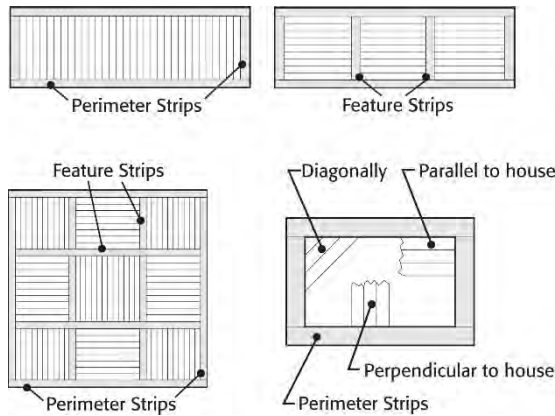

Board Spacing

Always leave a minimum gap of $1/8$ ” to allow for expansion. Siding or molding can later conceal this gap.

Allow a gap of $3/16$ ” between the deck board any rail system posts or other obstructions. The post sleeve and post base trim will cover the gap when placed over the post.

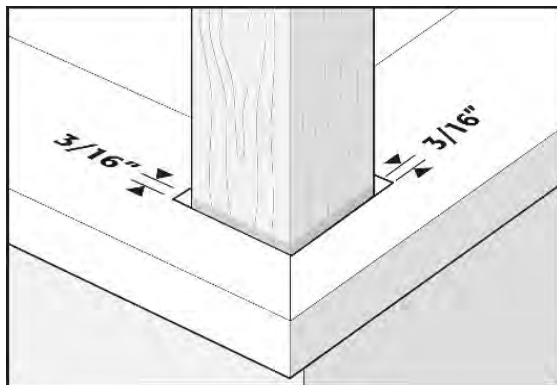

Board Gapping

Keep the decking installation square as you proceed. Check for square every few boards and adjust the board-to-board gap as necessary to compensate. Maintain a minimum board-to-board gap to assure proper drainage of rain and snow melt.

Traditional (S4S) deck boards should be installed with a spacing guide to ensure a minimum of $3/16$ ” of space between boards.

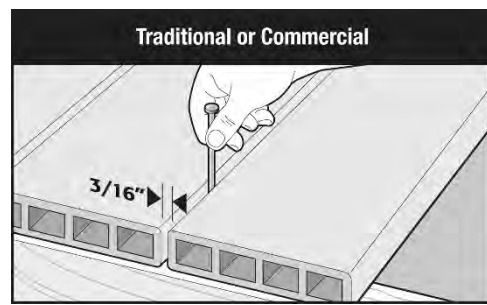

Tongue & Groove boards should be installed with a gap of $1/32$ ” to $1/16$ ”. Always use a spacing guide to maintain that spacing. DuxxBak Composite Decking has spacing guides available. Spacing of $1/20$ ” will better assure that expansion conditions will not cause damage. An installation that is not properly gapped will restrict water run-off and may cause buckling, damaging the board and voiding the DuxxBak Composite Decking warranty.

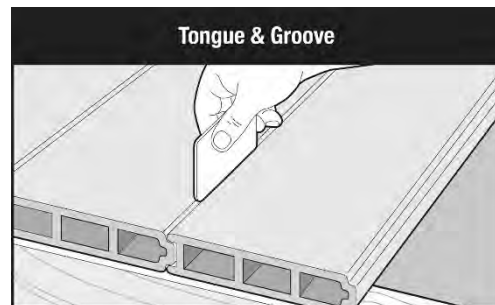

Fasteners

Avoid fastening within 3/4" of the ends of the deck boards to prevent cracking.

See www.duxxbakdecking.com for specific fastener recommendations.

One of several fastening systems may be used to nicely conceal the fasteners resulting in a neatly finished deck surface.

UFO Ballistic Nailscrews are available at DuxxBak Composite Decking. These are inserted with a pneumatic nailer and can be removed with a screwdriver if that becomes necessary.

Splitless ring shank siding nails that closely match **I.Dekk** colors can also be used. These are available through hardware outlets and are insert with a pneumatic nailer.

A pneumatic nail gun *with an adjustable tip*, such as a siding/fencing nailer can generally be use. Adjust the air pressure to ensure consistent setting for proper nail penetration. Check for correct pressure by testing the nail gun with the chosen fastener on a scrap board.

I.Dekk Traditional S4S Decking:

Use #7, #8 or #9 stainless or coated "Trim Head" screws 2-1/4" (or longer). DuxxBak Composite Decking can supply #7 x 2-1/2" "Finish Head" screws.

Apply a minimum of two fasteners on every joist, and three at the ends of each board.

If using a Feature Strip, allow the ends that will butt the Feature Strip to run long and overlap the opening where the Feature Strip will be installed. These ends will be trimmed to length later. (See Feature & Perimeter Strip Installation on page 12.)

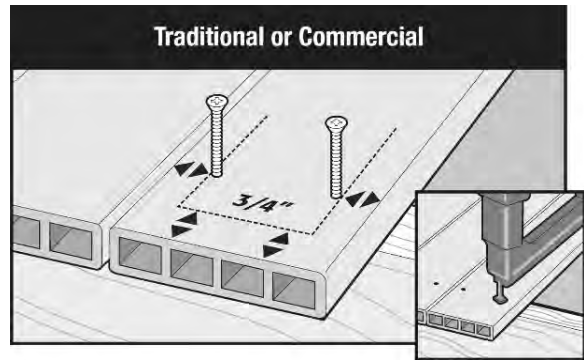

I.Dekk Tongue & Groove Decking:

Use #7, #8 or #9 stainless or coated "Trim Head" screws 2-1/4" (or longer). DuxxBak Composite Decking can supply #7 x 2-1/2" "Finish Head" screws.

Apply one fastener on every joist. It is also recommended to apply two fasteners through the face at the end of each board.

Fasteners should be driven through the tongue at a 55° to 60° angle to the horizon, through the tongue-to-shoulder junction, and into the joist below. Assure that a gap of 1/32" to 1/16" is provided. Use a gauge to assure uniform gapping. An installation that is too tight will restrict water run-off and may cause buckling.

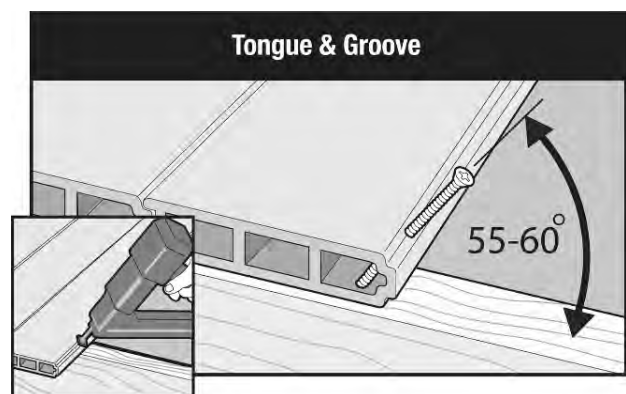

Perimeter Strips and Feature Strips:

Use #7, #8 or #9 3" (or longer) stainless or coated "trim head" screws, or 8d 3" (or longer) stainless or coated ring shank "siding" nails.

Insert the fasteners through the 5/4" hollow portion of the board. **Do not fasten through the wing (flat edge) that overlaps the deck boards.**

Insert 2 fasteners every 16 to 24 inches. Avoid fastening within 3/4" from the ends of the boards. Trim head screws can be driven just below the surface of the board and hidden by using a hammer to gently tap the decking material over the screw head.

Fascia:

Use a minimum of three fasteners every 12". Use a minimum of two fasteners every 12" if the Fascia has been ripped down to 6" or less in width.

The same fasteners used on the deck may be used on the Fascia.

Use corner molding when two Fascia boards meet at an angle. Corner molding can be fashioned from other **I.Dekk** stock board pieces.

To join two or more pieces of the Fascia board, butt the boards with a 1/8" to 3/16" gap and cover the gap with a 1" to 2" piece of trim nailed vertically. This allows the board to slide behind and conceal any contraction and expansion.

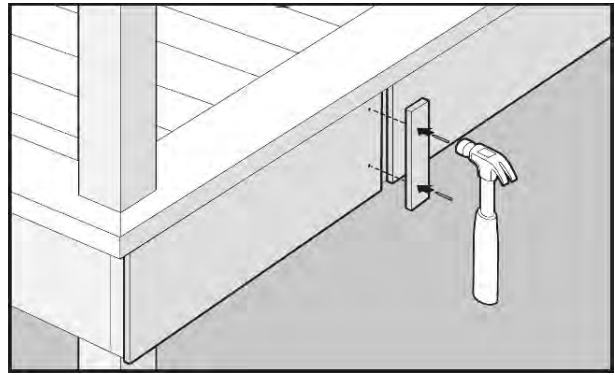

PARALLEL OR PERPENDICULAR DECKING INSTALLATION

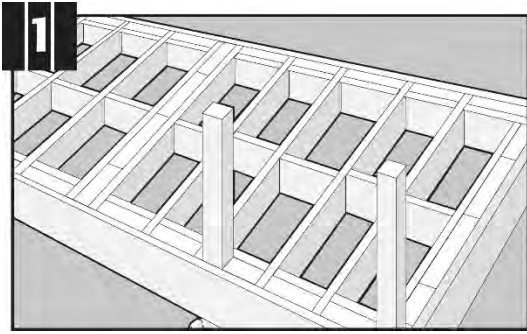

Start decking. Leave 1/8" between house; cover later with siding or molding.

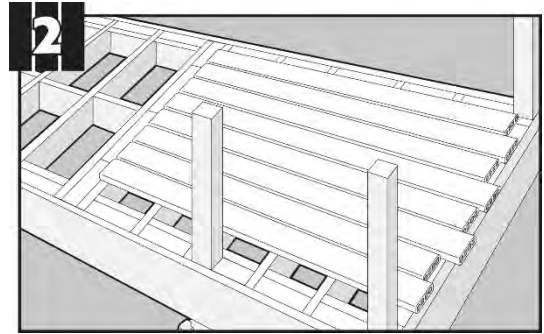

Install boards with extra to be trimmed later.

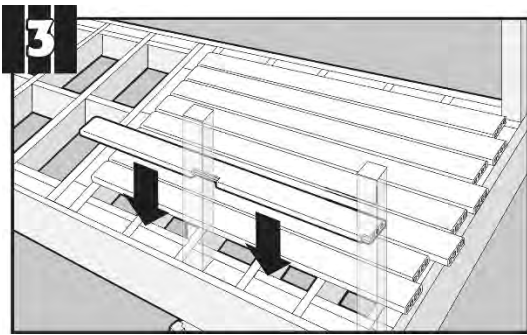

Mark and cut boards next to posts or house to actual length before attaching. The skill saw will not cut up to these areas.

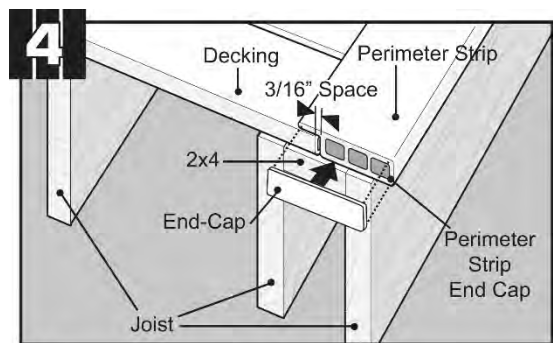

Boards should overlap joist (allowing 3/16" for expansion / contraction) where Perimeter Strips and Feature Strips will be added.

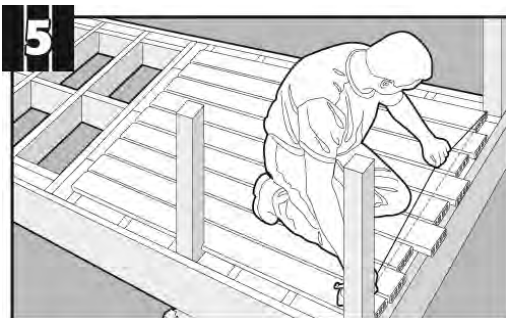

Snap a chalk line to indicate final cut length. Recommend using white or blue chalk.



Cut off excess.

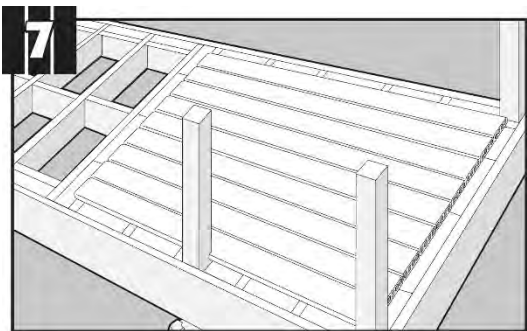

Install Feature and Perimeter Strips when all decking is complete.

DIAGONAL DECKING INSTALLATION

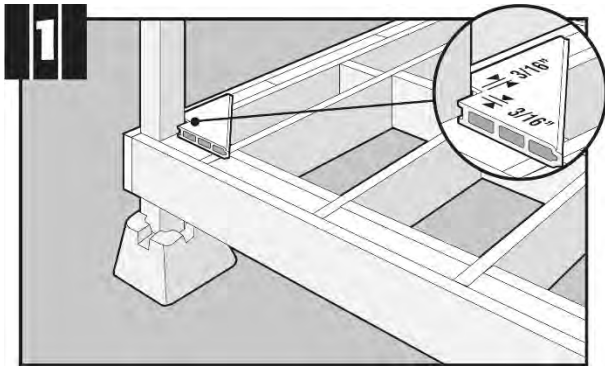

1 Cut corner piece and attach for guide. Always fasten $\frac{3}{4}$ " from edge of board.

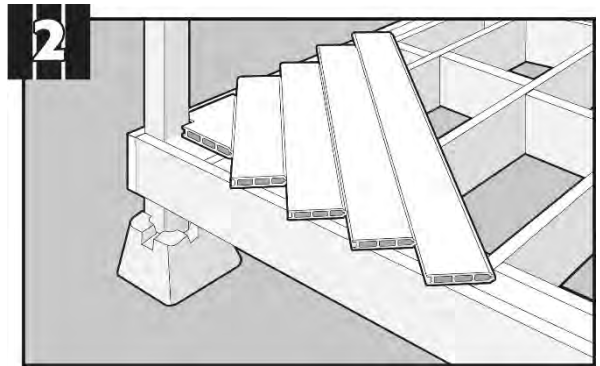

2 Cut and attach boards as you go. Trim excess *after* all boards are attached.

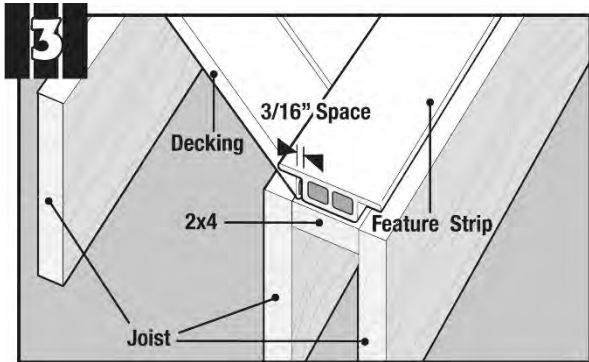

3 Boards should overlap joist (allowing $\frac{3}{16}$ " for expansion / contraction) where Perimeter Strips will be added.



4 Snap a chalk line on all edges to indicate final cut length.



5 Cut off excess.

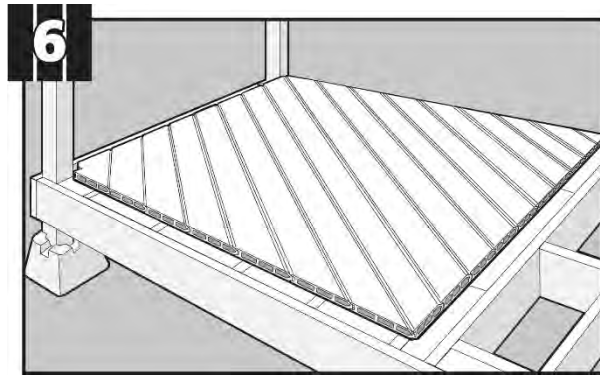

6 Install Feature and Perimeter Strips when all decking is complete.

FEATURE STRIP, PERIMETER STRIP & FASCIA BOARD INSTALLATION

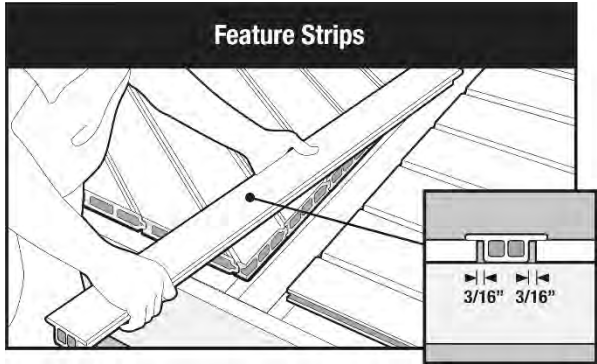

Feature Strips are placed between decking joints.



Completed deck after all Feature and Perimeter Strips have been installed.

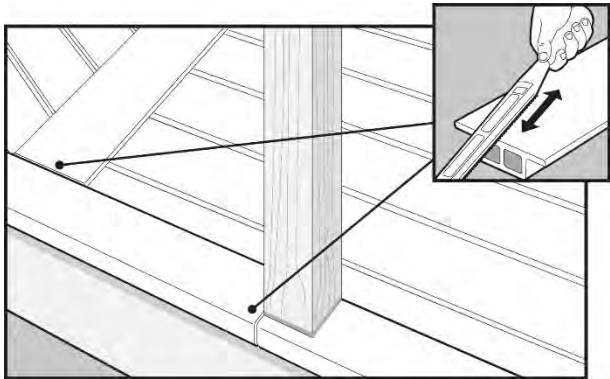

File or route edges when butt joints are unavoidable. To minimize the appearance of expansion and contraction, always butt Perimeter Strips at a post. The joint will be less visible when behind a post and covered with base trim.

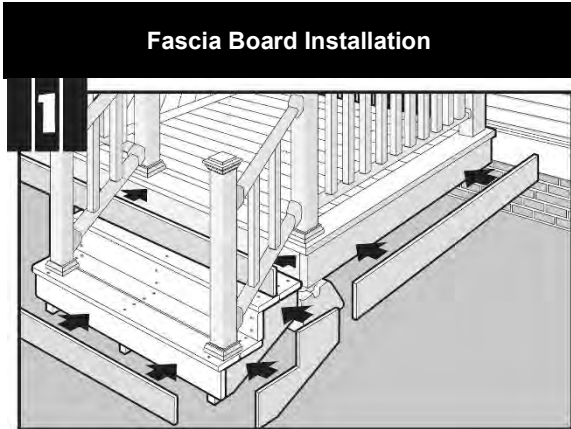

Measure areas to be covered with Fascia. Cut and attach with three fasteners every 12" using same fasteners used for decking. If the Fascia is 6" wide or less, two fasteners every 12" should be used.

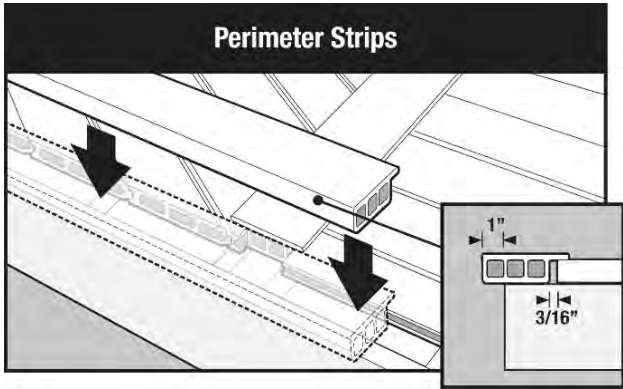

Perimeter Strips are placed around outer edge of decking. Allow for a maximum overhang of 1".

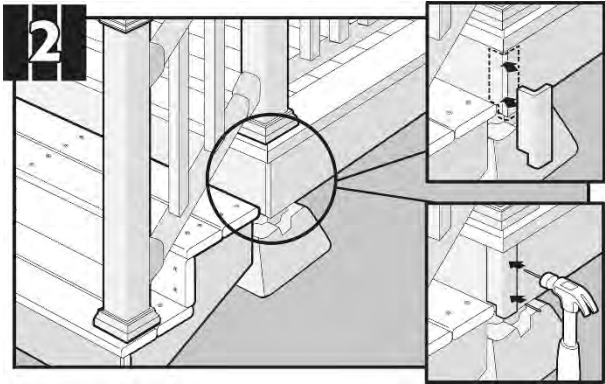

Baluster or post sleeve material can be used to cover corners. Attach with brads on one side only to allow for expansion and contraction.

I.Dekk®

DuxxBak Composite Decking is very proud of our industry leading Warranty. For your convenience, we have made the Warranty Agreement, Warranty Registration, and Warranty Claim forms available online.

Warranty Agreement	https://www.duxxbakdecking.com/warranty-2/
Warranty Registration	https://www.duxxbakdecking.com/warranty/
Warranty Claim Form	https://www.duxxbakdecking.com/warranty-claim/

Processing claims in a timely manner is part of our industry leading warranty. In order for our team to process claims, we encourage you to submit the Warranty Registration as soon as the construction is complete. Likewise, if a warranty claim is necessary, timely submission of the warranty claim, at the first sign of failure, is imperative.

Product Features

Resistance to Decay and Mold
Strength & Durability
Less Maintenance
Eco-Friendly
Easy To Install
Lifetime Limited Warranty

For The Pros

Unique Tongue & Groove profile quickly installs without hidden fasteners

I.Dekk Traditional S4S and T&G deck boards are PFS-Teco rated for 16" on center installation.

I.Dekk can be installed in varying patterns including diagonal, octagon, and herringbone patterns

You can use your imagination.

For the most up-to-date installation instructions, please visit
www.duxxbakdecking.com



A Division of Green Bay Decking, LLC

1518 South Broadway
Green Bay, WI, 54304
Tel 877-804-0137